

Kamera HIKVISION
DS-2CD2743G0-IZS
PD/11/21

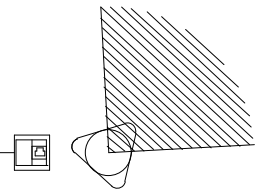

Kamera HIKVISION
DS-2CD2743G0-IZS
PD/11/12

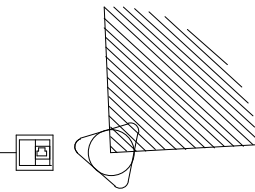

Kamera HIKVISION
DS-2CD2743G0-IZS
PD/11/3

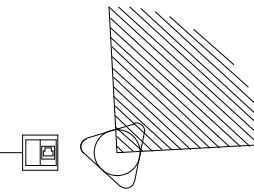

Kamera HIKVISION
DS-2CD2743G0-IZS
PD/11/22

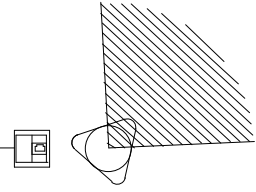

Kamera HIKVISION
DS-2CD2743G0-IZS
PD/11/13

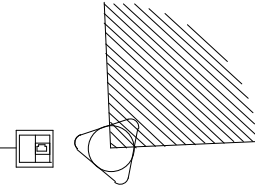

Kamera HIKVISION
DS-2CD2743G0-IZS
PD/11/4

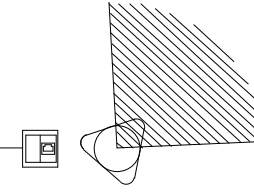

Kamera HIKVISION
DS-2CD2743G0-IZS
PD/11/23

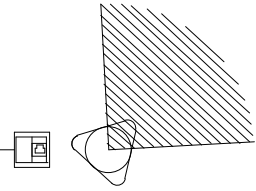

Kamera HIKVISION
DS-2CD2743G0-IZS
PD/11/14

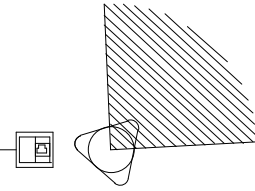

Kamera HIKVISION
DS-2CD2743G0-IZS
PD/11/5

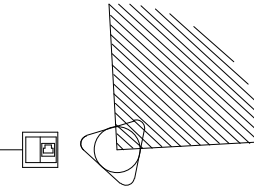

Kamera HIKVISION
DS-2CD2743G0-IZS
PD/11/24

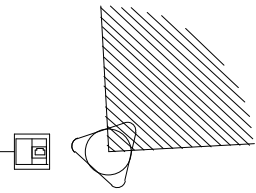

Kamera HIKVISION
DS-2CD2743G0-IZS
PD/11/15

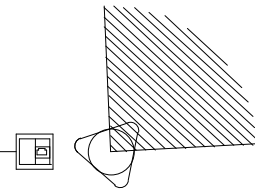

Kamera HIKVISION
DS-2CD2743G0-IZS
PD/11/6

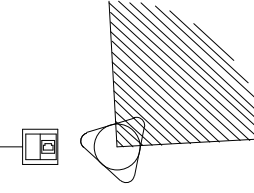

Kamera HIKVISION
DS-2CD2743G0-IZS
PD/12/1

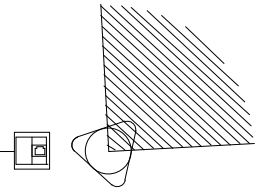

Kamera HIKVISION
DS-2CD2743G0-IZS
PD/11/16

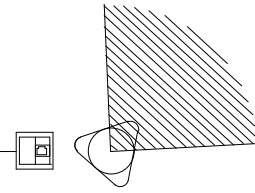

Kamera HIKVISION
DS-2CD2743G0-IZS
PD/11/7

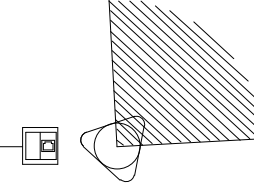

Kamera HIKVISION
DS-2CD2743G0-IZS
PD/12/2

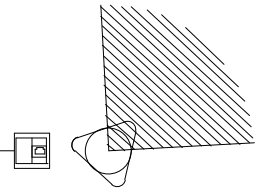

Kamera HIKVISION
DS-2CD2743G0-IZS
PD/11/17

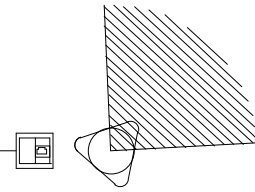

Kamera HIKVISION
DS-2CD2743G0-IZS
PD/11/8

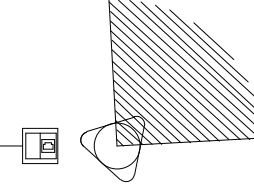

Kamera HIKVISION
DS-2CD2743G0-IZS
PD/12/3

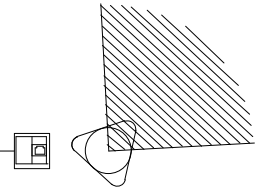

Kamera HIKVISION
DS-2CD2743G0-IZS
PD/11/18

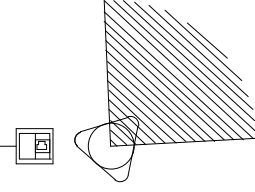

Kamera HIKVISION
DS-2CD2743G0-IZS
PD/11/9

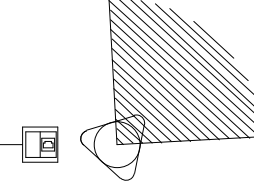

Kamera HIKVISION
DS-2CD2743G0-IZS
PD/12/4

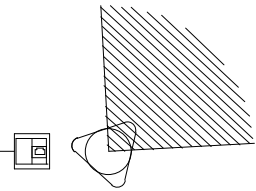

Kamera HIKVISION
DS-2CD2743G0-IZS
PD/11/19

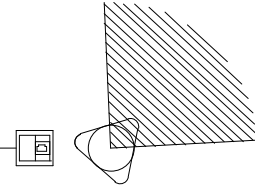

Kamera HIKVISION
DS-2CD2743G0-IZS
PD/11/10

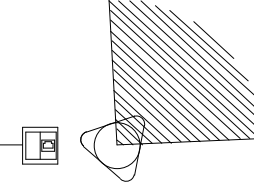

Kamera HIKVISION
DS-2CD1643G0-IZ
PD/12/5

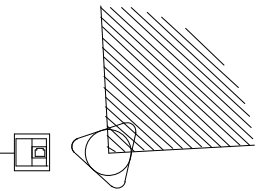

Kamera HIKVISION
DS-2CD2743G0-IZS
PD/11/20

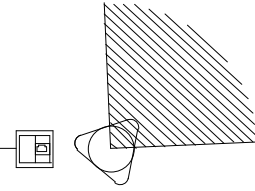

Kamera HIKVISION
DS-2CD2743G0-IZS
PD/11/11

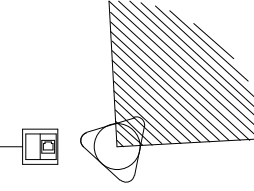

DS-2CD1643G0-IZ

29 x UTP 4x2x0,5 kat 6

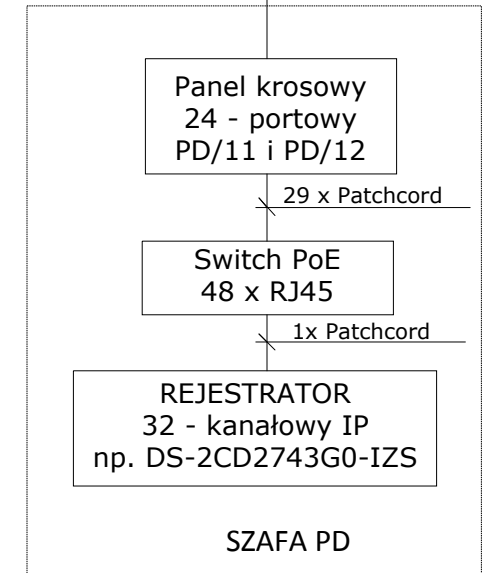

Kamera HIKVISION
DS-2CD2743G0-IZS
PD/11/1

Kamera HIKVISION
DS-2CD2743G0-IZS
PD/11/2

UWAGA!!!
UŻYTE NAZWY WŁASNE MATERIAŁÓW, URZĄDZEŃ ORAZ NAZWY
PRODUCENTÓW STANOWIĄ JEDYNIĘ WZORZEC JAKOŚCIOWY I SA
PODANE W CELU OKREŚLENIA PARAMETRÓW TECHNICZNYCH
ORAZ WYMOGÓW JAKOŚCIOWYCH

Nazwa i adres obiektu budowlanego:
Zakład Pielęgnacyjno - Opiekuńczy jednostka ew. 046301_1
87 - 100 Toruń, ul. Służewska 7
obr. nr 76 dz. nr 35/1, obr. nr 69 dz. nr 363/2, obr. 69 dz. nr 337, 352, 353

projektant: upr. w sp. inst.-inż. (elektr.) do proj. b.o. data: podpis:
inż. JAN KASZUBSKI 629/66 07.2020

projektant: upr. w sp. inst.-inż. (elektr.) do proj. b.o. data: podpis:
mgr inż. RAFAŁ DRYGALSKI POM/0184/POOE/08 07.2020

Nazwa rysunku: Schemat instalacji CCTV skala:

faza projektu: PROJEKT WYKONAWCZY branża: TELETECHNICZNA format: nr rys.: T-04